

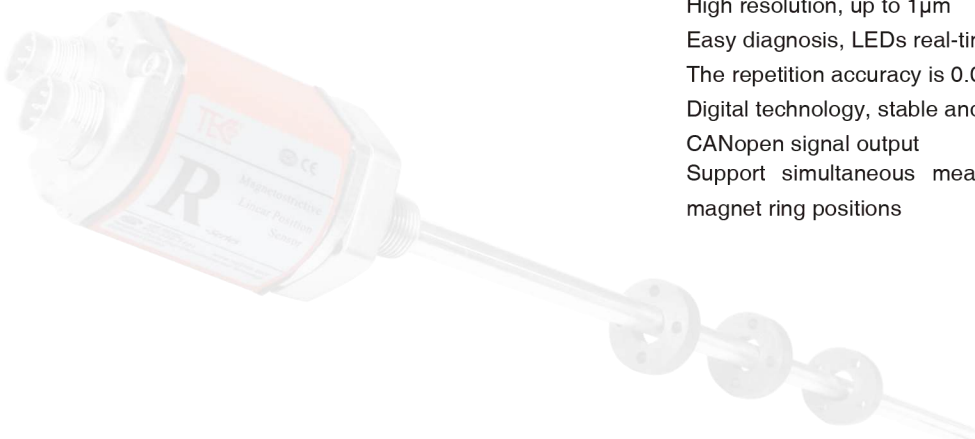

Technical Characteristics

- Rugged and fully enclosed design
- Non-wear, non-contact measurement method
- Linear measurement, absolute output
- High resolution, up to 1 μ m
- Easy diagnosis, LEDs real-time condition monitoring
- The repetition accuracy is 0.001% F.S
- Digital technology, stable and reliable
- CANopen signal output
- Support simultaneous measurement of multiple magnet ring positions



Product Parameters-CAN Bus Output

Input

Measurement data	Position magnet ring
Stroke length	25~5500 mm, customized according to customer needs
Number of measurements	1~9

Output

Interface	CANBus System Protocol, ISO15745
CANopen	CIA Standard DS-301V3.0 Encoder Profile DS-406V3.1
Transmission speed	Maximum 1Mbit/s
Resolution	1 / 2 / 5 / 10 / 20 / 50 / 100 μm
Nonlinearity	< 0.01% full-scale taxi, minimum 50μm
Repetition accuracy	<±0.001% of full scale, minimum ±1μm
Update time	1KHz (range ≤1m) 500Hz (1m< range ≤2m) 250Hz (2m< range ≤3m) , customizable
Hysteresis	<10μm
Temperature coefficient	<15ppm/°C

Operating conditions

Magnet velocity	Arbitrary
Protection level	IP67RH Stainless Steel Rod/IP65RP Aluminum profile
Operating temperature	-40 °C ~ +85 °C
Humidity/dew point	Humidity 90%, no condensation
Shock index	GB/T2423.5 100g(6ms)
Vibration index	GB/T2423.10 20g/10~2000Hz
EMC Test	GB/T17626.2/3/4/6/8, Grade4/3/4/3/3, Class A, CE Certification

Structure and Material

Failure indication	Electronic bin coverwith LEDs display
Electronic bin	Aluminum alloy
Measuring rod	304 stainless steel
RH Series	Outer tube pressure 35MPa (continuous)/70MPa (peak) or 350bar (continuous)/700bar (peak)
Position magnet	Standard magnet ring and various ring magnets
RP Series	Electronic bin Aluminum alloy
Measuring rod	Aluminum alloy
Position magnet	Slider magnet, square magnet, sector magnet
Mounting thread form	M18×1.5、 M20×1.5、 3/4"-16UNF-3A (customizable)
Installation direction	Any direction
Outgoing mode	Cable outlet or Connector

Electrical Connection

Input voltage	+24Vdc±20%
operating current	<80mA (varying with range)
Polarity protection	Max.-30Vdc
Overvoltage protection	Max.36Vdc
Insulation resistance	> 10MΩ
Insulation strength	500V

SS Output Characteristics-CAN Bus Output

- Connect by 6-pinconnector (series connection)

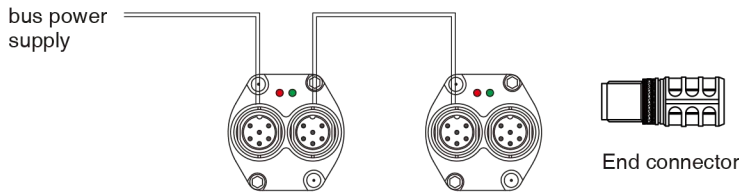

LT LED Real-time State Monitoring and Diagnosis

- As a slave station, CAN output magnetostrictive displacement sensor can upload the displacement information and velocity information of the vernier magnet to the controller in real time through bus. It conforms to CAN (ISO 11898) protocol standard, and the maximum transmission rate is 1Mbit/s.
- The integrated LEDs (red or green) provide the basic status feedback and troubleshooting function of the sensor.

Green light	ON	ON	ON	Flash
Red light	OFF	Flash	ON	ON
Function	Normal work	The magnet leaves the Stroke length range	Magnet not detected	Programming state

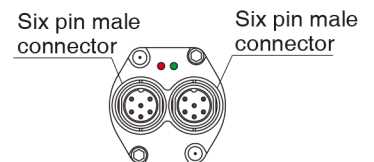

A a Installation Instructions-CAN Bus Output

- Dimensions and installation guidance of RH pressure-resistant rod sensor

RH series pressure-resistant rodshell, built-in installation design for hydraulic system, pressure-resistant 35MPa continuous, flexible and simple installation mode, mounting thread form M18×1.5 or M20×1.5 or 3/4"-16UNF-3A.

Note: The measurement Non-usable area shown in the figure indicates that the output value of the sensor in this area is zero or unreliable. The values of the head and end non-usable areas of this product are 50.8mm and 63.5mm respectively. The value of the measurement non-usable area can be appropriately modified according to the needs of customers, please pointed out when ordering.

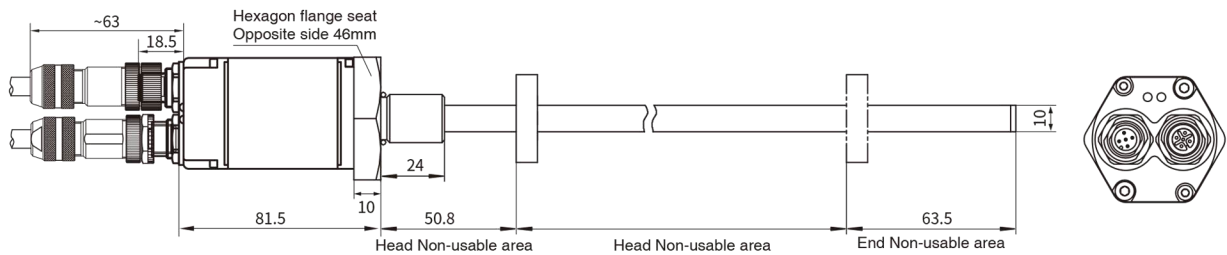
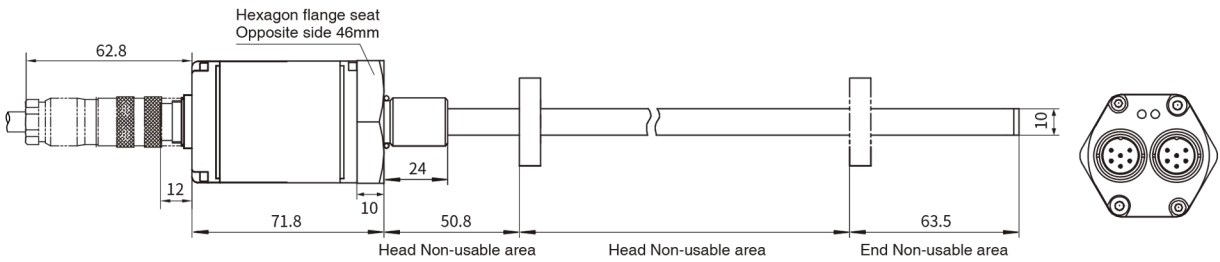
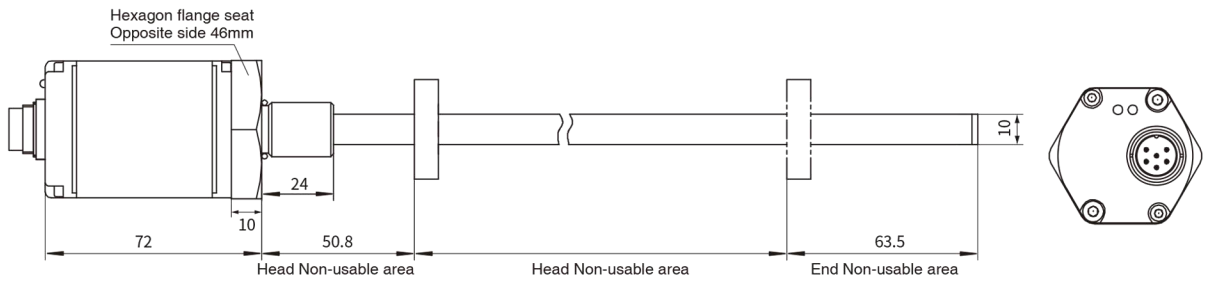
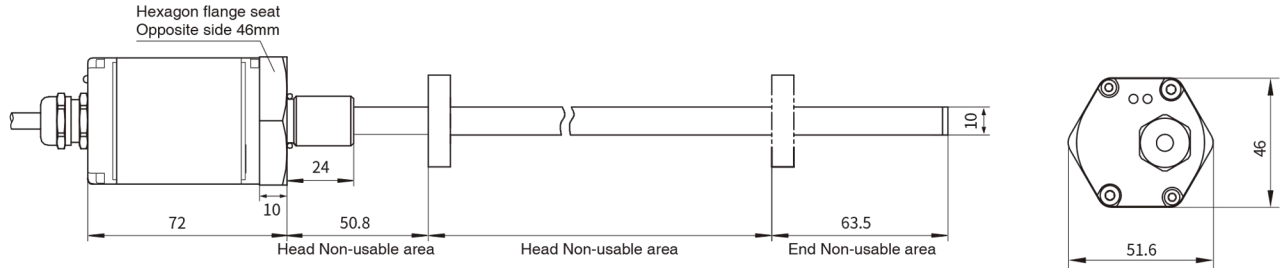

A a Installation Instructions-CAN Bus Output

• Dimensions and installation guidance of RP aluminum profile sensor

RP Series aluminum profile provides flexible and simple external installation mode, which is suitable for stroke or position detection of linear motion mechanism, and can also be used for external position detection of hydraulic cylinder.

Note: The measurement Non-usable area shown in the figure indicates that the output value of the sensor in this area is zero or unreliable. The default value of the measurement Non-usable area at the head and end of this product is 28mm and 66mm respectively. The value of the measurement Non-usable area can be modified appropriately according to the customer's needs, please pointed out when ordering.

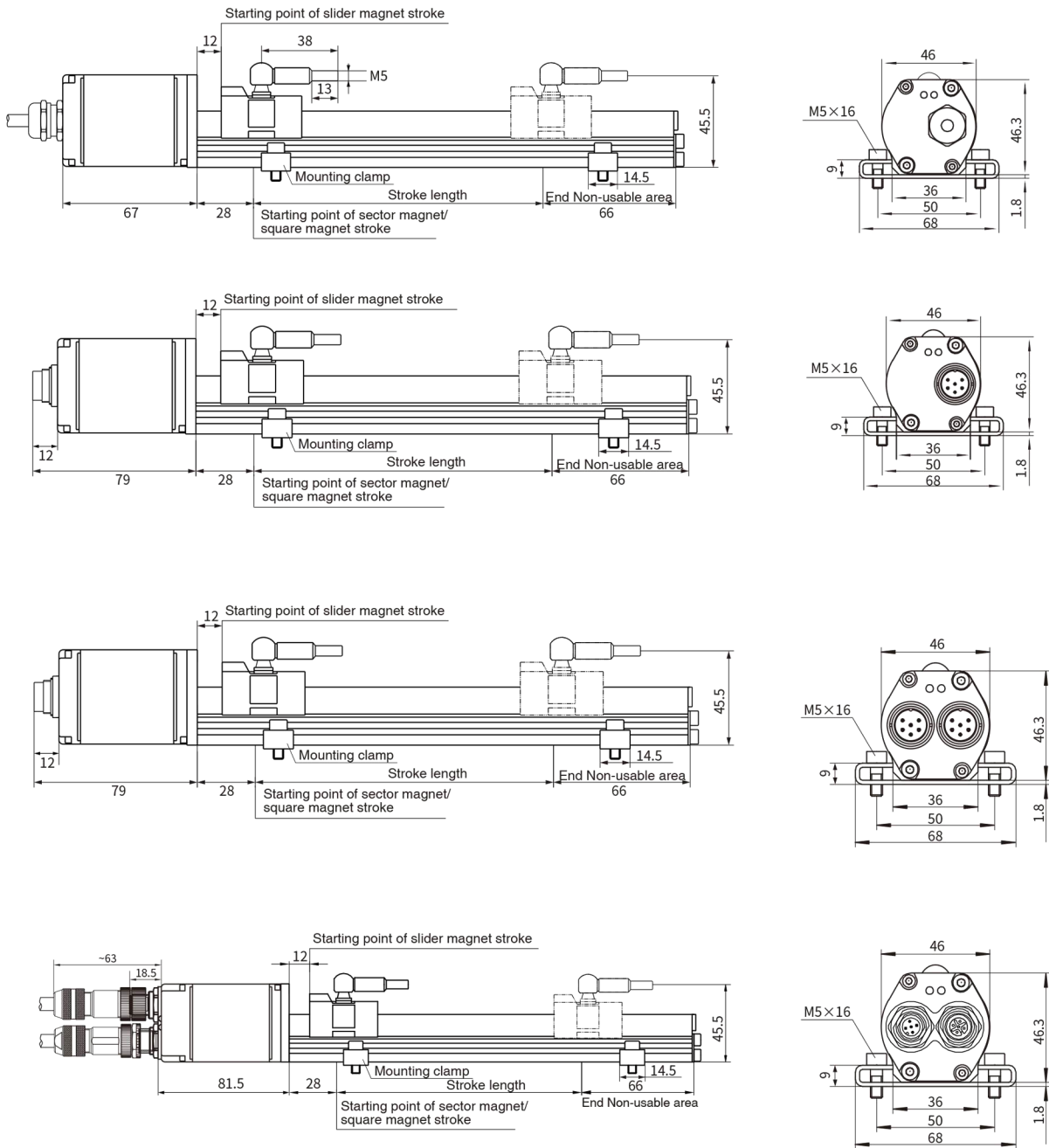

Common Accessories - CAN Bus Output

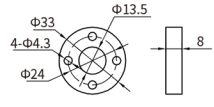
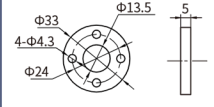
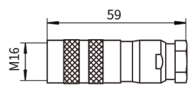
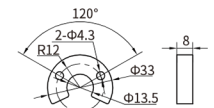
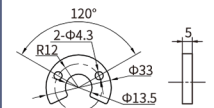
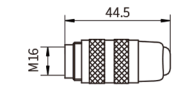
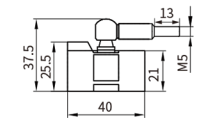
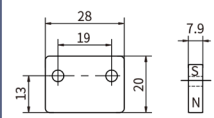
Accessory name/ model	Dimensions	Accessory name/ model	Dimensions	Accessory name/ model	Dimensions
Standard Magnet ring Order No.: 211501		Magnetic isolation gasket		6-pin female connector Order No.: 312701	
Sector magnet Order No.: 211502		Sector magnetic isolation gasket		6-pin end female connector Order No.: 312722	
Slider magnet Order No.: 211503		Square magnet Order No.: 211508			

Note: Please refer to "Magnet ring Selection" for details of magnet ring kit and other models.

Wiring mode

When the sensor is connector output, refer to the pin definition in the following table for wiring mode; when the sensor is cable outlet output, refer to the line color definition in the following table for connection mode

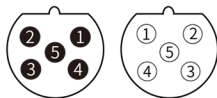

5-pin male connector and female connector pin arrangement (facing the sensor head direction)

Pin	Line color	Pin/wire function definition
1	-	Do not connect
2	Brown	+24Vdc power supply (-20%~+20%)
3	White	0Vdc (power supply loop)
4	Yellow	CAN (+)
5	Green	CAN (-)

6-pin male connector arrangement (facing the sensor head)

Pin	Line color	Pin/wire function definition
1	Green	CAN (-)
2	Yellow	CAN (+)
3	-	Do not connect
4	-	Do not connect
5	Brown	+24Vdc power supply (-20%~+20%)
6	White	0Vdc (power supply loop)



4-pin connector socket (for power supply)

4-pin male connector pin arrangement (facing the sensor head direction)

Pin	Line color	Pin/wire function definition
1	Brown	+24Vdc power supply (-20%+20%)
2	White	Do not connect
3	Blue	0Vdc(power supply circuit)
4	Black	Do not connect

X X Selection Guide-CAN Bus Output

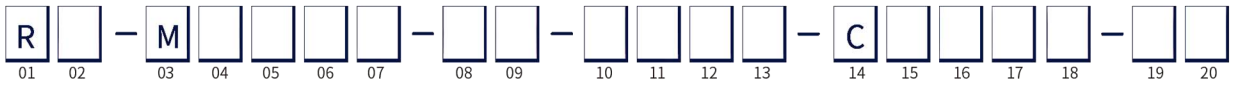

01-02 Sensor shell form

R	H	Pressure-resistant rod (internal or external)
R	P	Aluminum profile (external only)

03-07 Measuring range

Four digits, less than four digits are preceded by zero, M means metric system, unitmm

08-09 Magnet ring type/mounting thread form

Only for RH series	S	1	M 18×1.5, measuring rod diameter 10mm, 304 material
	S	2	M20×1.5, measuring rod diameter 10mm, 304 material
	S	3	3/4 "-16UNF-3A, measuring rod diameter 10mm, 304 material
Only for RP Series	C	1	Sector magnet
	C	2	Slider magnet
	C	3	Square magnet

10-13 Connection form

10-11 Cable outlet mode

D	A	Single cable outlet, PUR sheath, cyan, -20~80C, end scattered
---	---	---

12-13 Cable outlet mode: cable length, 0199 meters

0	D	R	1	PVC sheath, length 150mm, end 5 pin male connector
---	---	---	---	--

10-13 Connector mode

P	D	6	0	6-pin male connector (M16)
P	D	6	2	Two sets of 6-pin male connectors (M16)
P	D	5	0	5-pin male connector (M12)
P	D	5	2	5-pin male connector (M12) and 5-pin female connector (M12)
P	D	5	4	5-pin male connectors (M12), 5-pin female connectors (M12), 4-pin male connectors (M8)

For supporting cables, please refer to CAN bus cable accessories selection

14-18 Signal output mode

14 Interface

C	CAN bus
---	---------

15 Protocol type

1	CANopen	2	CANBasic
---	---------	---	----------

16 Baud

1	1000kBit/s	2	800kBit/s
3	500kBit/s	4	250kBit/s
5	125kBit/s	6	100kBit/s
7	50kBit/s	8	20kBit/s

17 Resolution

1	0.1mm	2	0.05mm
3	0.02mm	4	0.01mm
5	0.005mm	6	0.002mm
7	0.001mm		

18 Number of magnet rings (1~9 optional)

19-20 Non-usable area at head and end, customizable

S	0	50.8mm+63.5mm
B	0	30mm+60mm
S	1	28mm+66mm (used in RP series)

Note: The forward output of the sensor means that when the magnet ring moves away from the electronic bin, the output value increases and decreases when the magnet ring moves in the reverse direction.

Selection example: RH-M0300-S1-PD60-C1171-S0

Indicates: The ordered product model is RH structure displacement sensor, the measuring range is 300mm, the mounting thread form is M18×1.5 (metric system), the measuring rod diameter is 10mm, the material is 304, One set of 6-pin male connector, the baud is 1000kbit/s, the resolution is 0.001mm, single magnet ring, the Non-usable area at the head is 50.8mm, and the Non-usable area at the end is 63.5mm.

CC Selection of CAN Bus Cable Accessories

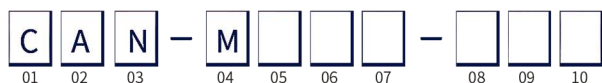
01-03 Type

C	A	N	CAN bus
---	---	---	---------

04-07 Cable length

M	*	*	*	Less than 3 digits are preceded by zeros, and M means metric system, unit m
---	---	---	---	---

08-10 Cable type, outlet mode
08 Cable type

C	PVC sheath, purple, 4 cores,-40~75C
---	-------------------------------------

09-10 Connection

0	1	One end of 6-pin (M16) female connector, and one end scattered
0	2	One end of 5-pin (M12) female connector, and one end scattered
0	3	One end of 5-pin (M12) male connector, and one end scattered
0	4	One end of 5-pin (M12) right angle female connector, and one end scattered
0	5	One end of 6-pin (M16) right angle female connector, and one end scattered
1	1	6-pin (M16) female connector at both ends
2	3	One end 5-pin (M12) female connector and one end 5-pin (M12) male connector

Selection example: CAN-M015-C01

Indicates: CAN bus interface cable, 15m long, PVC sheath, purple, 4-pin,-40~75C, 6-pin (M16) at one end of the cable are female connector, and one end scattered.

Selection example: CAN-M020-C23

Indicates: CAN bus interface cable, 20 meters long, PVC sheath, purple, 4 cores,-40~75C, with 5-pin (M12) at one end female connector and 5-pin (M12) at the other end male connector.

